



CROSS-BAR[®] COOLER

The Art of Cooling Clinker

EFFICIENT COOLING WITH A LOW TCO – NOW THAT’S COOL

You need three things from your cooler: high uptime, quick cooling, and the capability to recoup as much heat as possible. With very low maintenance requirements and advanced, R&D-led design, the Cross-Bar® cooler delivers on all fronts, giving you optimum cooler performance with a low total cost of ownership.

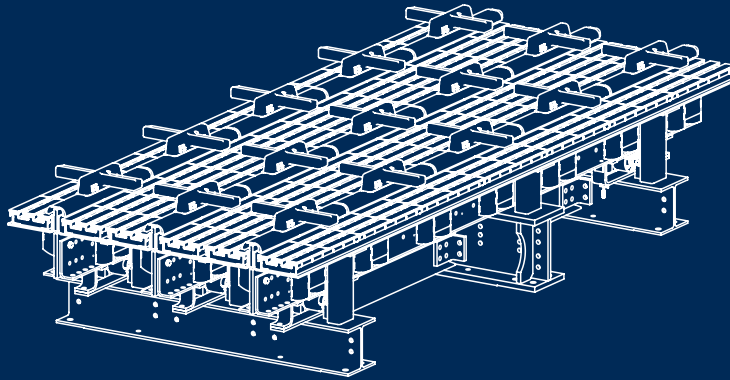

KEY BENEFITS

No snowmen

Robust cooler

High thermal recuperation

Low maintenance

Hot air recirculation (up to 130 °C)

Energy efficient



Cross-bar® Cooler

The latest Generation Cross-Bar® Cooler, designed for maximum uptime

Cooler downtime causes lost productivity and lost profits. The best way to reduce downtime is to choose a cooler that is designed to withstand the extreme conditions of the operation. The Cross-Bar® cooler is designed to be operational for 330 days a year, just like your kiln.

Less moving parts, less contact between clinker and machinery, and smart engineering that eliminates both agglomeration and Snowmen. That's what we've achieved with the Cross-Bar® cooler, which comes with the snowman-eliminating ABC Inlet as standard. To ensure maximum cooling efficiency, we use self-adjusting mechanical flow regulators in essential zones to control the flow of ambient air through the clinker bed.

It's efficient. It's reliable. And it reduces both power and fuel consumption, helping to curb carbon emissions. You can't get cooler than that.

PROVIDES ALL THAT YOU NEED FROM THE COOLER

No more snowmen

When snowmen build up, the cooler goes down. While you can 'fire-fight' the beginnings of agglomeration, there comes a time when your only recourse is to shut down the pyro system for a clearout. Each time this happens you lose days of production and consume excess fuel getting the pyro line back up to temperature again. It's expensive, stressful and unsustainable. No process can afford repeated shutdowns over an extended period.

Destroying snowmen should not be part of your 'business as usual'. They should never be able to form in the first place. That's the basis of the ABC Inlet.

Better air flow

In the old-style moving grate coolers, air flow consistency was disrupted by wear to the grates. With Mechanical Flow Regulators (MFR) in essential zones, we have the opportunity to optimise air flow to maximise cooling and recuperation efficiency.

The MFR acts as a flow limiter in places where more air flow than needed typically passes through due to the lesser degree of resistance, such as through the coarse clinker layer. It works without operator intervention and gives you fuel savings and – because less cooling air input is required to cool the clinker – a substantial reduction in power consumption.

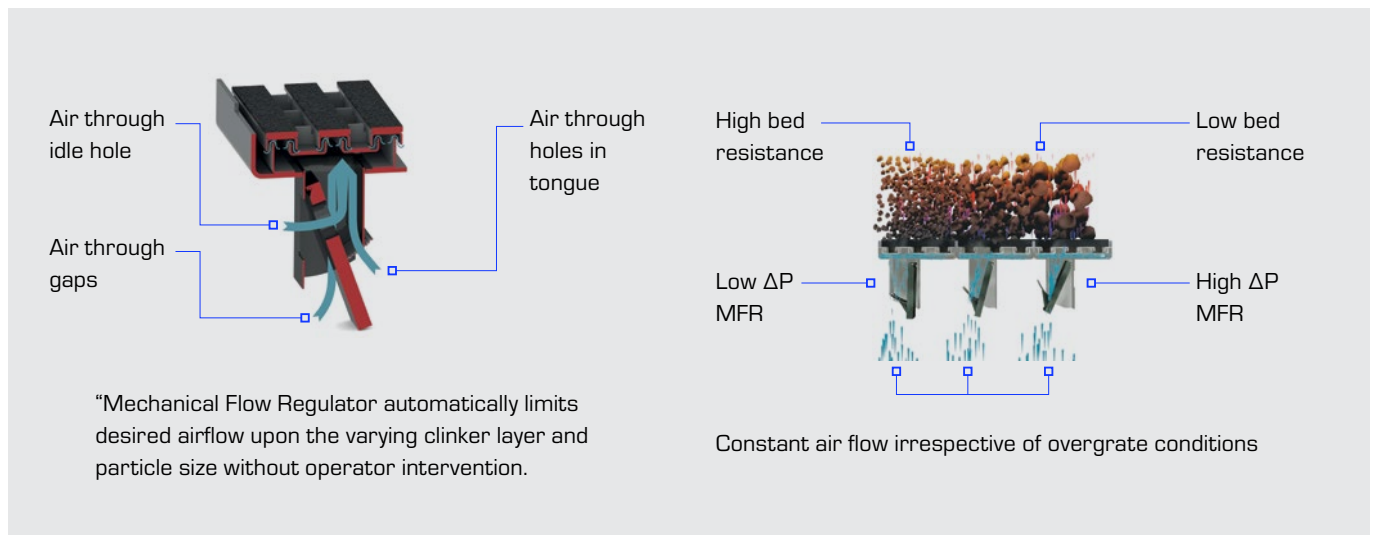

No gaps, no loss of efficiency

One of the main benefits of this approach is that the gradual wear of the cross bars has no impact on cooler efficiency. By comparison, on moving grate cooler models, the grate plates wear and create gaps between plates, which leads to inefficient cooling and poor thermal efficiency – and all the additional problems that arise from clinker exiting the cooler without having cooled sufficiently.

Furthermore, because the Cross-Bar cooler is designed with no moving grates and a well-proven seal arrangement, there's also no possibility for clinker to fall below the grates, which means you no longer need a conveying system underneath. One less thing to worry about.

High thermal recuperation for optimum efficiency

The heat from your cooling clinker is valuable. Not only does it hold the potential to reduce your fuel consumption in the kiln, it also opens up the possibility to burn more moist alternative fuels you might not otherwise consider viable. But you have a limited window for capturing this heat. That's why high thermal recuperation is a priority in the Cross-Bar® Cooler design.

Upgrading your existing old cooler with the latest generation Cross-Bar cooler will provide you heat consumption savings in the range of 20 – 60 kcal/kg of clinker depending upon the age and type of your existing cooler.

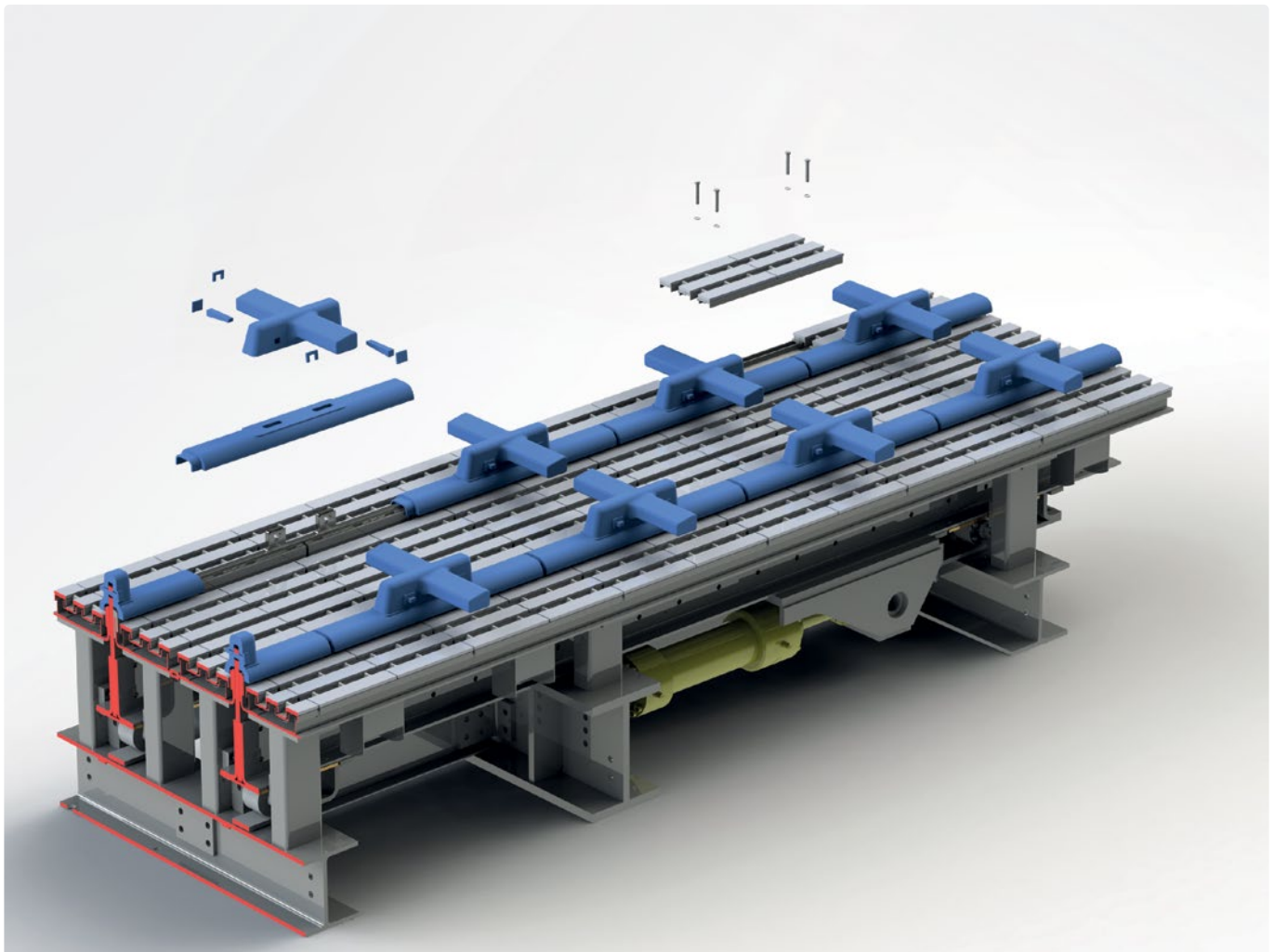

Rapid quenching

Getting the clinker temperature down quickly avoids the C3S reverting to C2S and impacting final cement strength. It also enables you to use that heat back in your kiln system. The Cross-Bar® Cooler is equipped with the ABC Inlet, which is designed for rapid quenching for faster and more even cooling. This rapid cooling also ensures you maintain the optimum chemical composition in the clinker, which both enhances the clinker quality and gives you more flexibility with your cement product.

Moving bars, not grates – low maintenance by design

Replacing worn grates or carrying out gap management on grate type coolers are time-consuming exercises and an on-going expense. In the Cross-Bar® cooler, clinker is moved through the cooler using horizontal bars that operate in a shuttle motion across a number of lanes. This effectively conveys, mixes and shears the clinker and prepares it for efficient exposure to the cooling air.

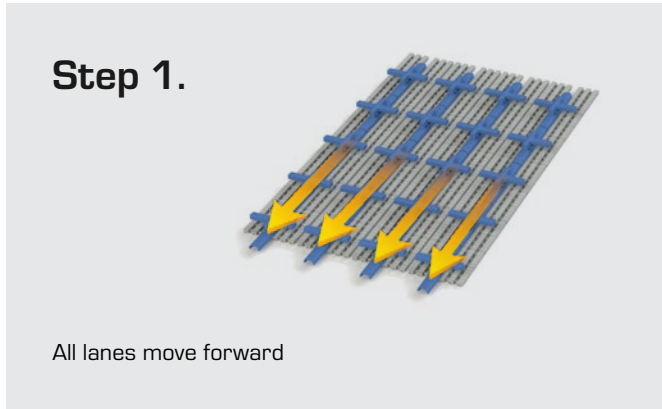

The cross bars are raised about 90 mm above the grate line so there is no contact with the grate itself, and the grate is further protected by a bed of clinker. This extends the grate life considerably in comparison with the moving grate cooler models.

The number of lanes across the cooler width provides flexibility to control red river formation. If you should see a red river, you can simply slow the clinker transportation in the affected lane to give the clinker more time to cool.

The Cross-Bar cooler is designed such that in most cases, you will only need one hydraulic cylinder per lane, reducing the maintenance burden.

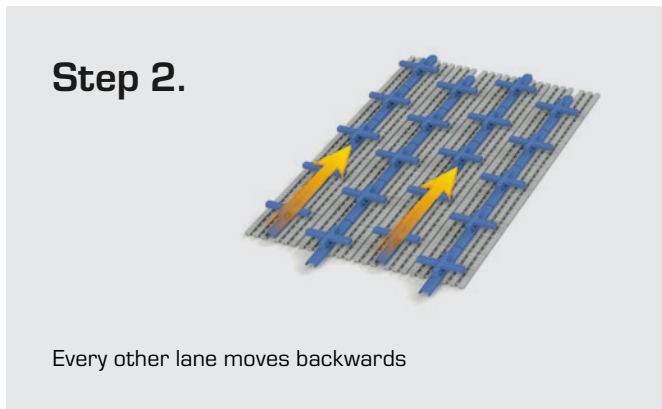

The modular FLSmidth® Cross-Bar® cooler reduces installation time and costs. It is manufactured to a high quality standard and ensures attractive equipment delivery times.

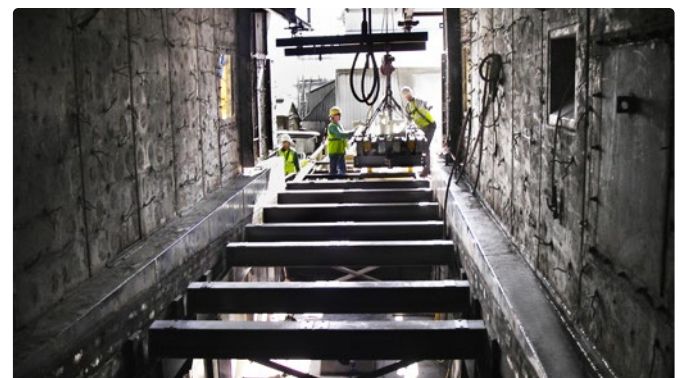
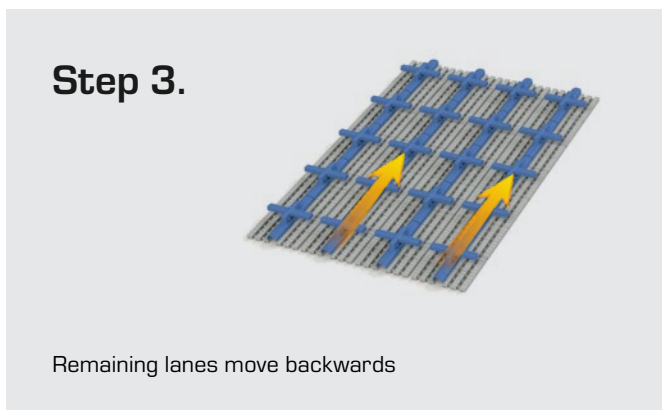

Installation of FLSmidth Cross-Bar cooler inside existing cooler housing

Helping you keep it cool

How does the ABC Inlet work?

Ordinary fixed inlets use air blasting to destroy agglomerations. These air blasters are built into the side walls and back of the cooler inlet. But with a maximum blast radius of about half a metre, there's a huge area in the centre of the inlet that the air can't reach.

That's where the snowmen can still form.

The ABC Inlet uses a patented in-grate design that pushes compressed air up through the grates, blasting agglomerations. Pressure sensors detect when build-up is starting to occur and the automated blast control system reacts accordingly, increasing blast frequency to disperse the clinker and prevent further agglomeration. Smart, targeted and efficient. The result? No snowmen. Ever.

Designed and built by experts

The Cross-Bar® Cooler can be a completely new installation or an upgrade for most existing coolers. This flexibility is possible thanks to the modular design, which can be tailored to fit most footprints. As far as possible, our coolers are preassembled in our workshop, ensuring rapid and hassle-free installation – often manageable within a standard annual maintenance shutdown.

Maximise waste heat recovery

It's not only in the first half of cooler where there is recuperated heat to be used. We can also integrate a waste heat recovery system to your Cross-Bar Cooler so that you can use the excess hot air elsewhere in your process. The processed air can also be recirculated back to the cooler under compartment at ≤ 130 °C to further boost the excess air heat content without affecting cooler efficiency.

This solution is suitable for new installations and upgrades and for partial or complete hot air recirculation, depending on your needs. Hot air recirculation can help you meet strict emissions requirements and maximise your waste heat recovery potential.



SIMPLE TO OPERATE

- Self-adjusting mechanical flow regulators
- No manual dampers
- No internal piping or air beams
- No sealing air fans
- Few fans



SIMPLE TO MAINTAIN

- No moving grates
- No clinker fall-through
- No side seals
- No spillage valves
- No undergrate conveying system
- Easy replacement of wear parts



www.flsmidth-cement.com

Copyright © 2024 FLSmidth Cement. All Rights Reserved. FLSmidth is a (registered) trademark of FLSmidth A/S, and FLSmidth Cement is authorized to use the trademark under a license agreement. This brochure makes no offers, representations or warranties (express or implied), and information and data contained in this brochure are for general reference only and may change at any time.

